



Surgical Home Internacional

Instrumental Quirurgico y Equipos Medicos

Histeroscopia



HYSTEROSCOPE SET HS101A



6417.22 Curved hysteroscope
22deg/6.4mm/170mm

5217.22 Curved hysteroscope
22deg/5.2mm/170mm

Connect ATOMX light cable
Connect STORZ light cable
Connect WOLF light cable
Connect OLYMPUS light cable
Connect ACMI light cable



Type A (plastic handle)

Type B (metal handle)

F6400BB Flexible biopsy forceps
6Fr/400mm (Type B)

F6400BA Flexible biopsy forceps
6Fr/400mm (Type A)

F6400SB Flexible scissors
6Fr/400mm (Type B)

F6400SA Flexible scissors
6Fr/400mm (Type A)

F6400GB Flexible grasping ring forceps
6Fr/400mm (Type B)

F6400GA Flexible grasping ring forceps
6Fr/400mm (Type A)

F6400G3 Flexible grasping forceps
6Fr/400mm (Type B)



F6400TB Flexible saw-tooth forceps
6Fr/400mm (Type B)



F6400TA Flexible saw-tooth forceps
6Fr/400mm (Type A)

F6400FB Flexible foreign body forceps
6Fr/400mm (Type B)



F6400FA Flexible foreign body forceps
6Fr/400mm (Type A)



W8300 Steel wire
0.8mm/300mm

B6000 Flexible brush
6Fr



A4303 Sealed cap



A4308 Infusion unit



HYSTEROSCOPE SET HS101B



6417.22B Curved hysteroscope(with handle)
22deg/6.4mm/170mm

5217.22B Curved hysteroscope(with handle)
22deg/5.2mm/170mm



Connect ATOMX light cable
Connect STORZ light cable
Connect WOLF light cable
Connect OLYMPUS light cable
Connect ACMI light cable



Type A (plastic handle)

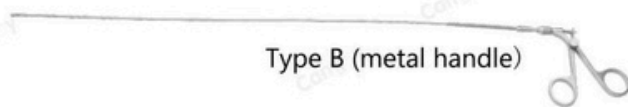

Type B (metal handle)

F6400BB Flexible biopsy forceps
6Fr/400mm (Type B)

F6400BA Flexible biopsy forceps
6Fr/400mm (Type A)



F6400SB Flexible scissors
6Fr/400mm (Type B)

F6400SA Flexible scissors
6Fr/400mm (Type A)



F6400GB Flexible grasping ring forceps
6Fr/400mm (Type B)

F6400GA Flexible grasping ring forceps
6Fr/400mm (Type A)



F6400G3 Flexible grasping forceps
6Fr/400mm (Type B)



F6400TB Flexible saw-tooth forceps
6Fr/400mm (Type B)

F6400TA Flexible saw-tooth forceps
6Fr/400mm (Type A)



F6400FB Flexible foreign body forceps
6Fr/400mm (Type B)

F6400FA Flexible foreign body forceps
6Fr/400mm (Type A)



W8300 Steel wire
0.8mm/300mm

B6000 Flexible brush
6Fr



A4303 Sealed cap



A4308 Infusion unit



HYSTEROSCOPE SET HS202



6220.00 Hysteroscope
0deg/6.2mm/200mm

5220.00 Hysteroscope
0deg/5.2mm/200mm

Connect ATOMX light cable
Connect STORZ light cable
Connect WOLF light cable
Connect OLYMPUS light cable
Connect ACMI light cable



Type A (plastic handle)

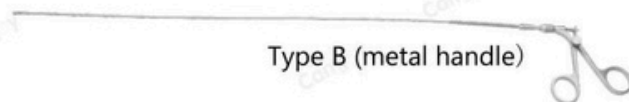

Type B (metal handle)

F6400BB Flexible biopsy forceps
6Fr/400mm (Type B)

F6400BA Flexible biopsy forceps
6Fr/400mm (Type A)



F6400SB Flexible scissors
6Fr/400mm (Type B)

F6400SA Flexible scissors
6Fr/400mm (Type A)



F6400GB Flexible grasping ring forceps
6Fr/400mm (Type B)

F6400GA Flexible grasping ring forceps
6Fr/400mm (Type A)



F6400G3 Flexible grasping forceps
6Fr/400mm (Type B)



F6400TB Flexible saw-tooth forceps
6Fr/400mm (Type B)

F6400TA Flexible saw-tooth forceps
6Fr/400mm (Type A)



F6400FB Flexible foreign body forceps
6Fr/400mm (Type B)

F6400FA Flexible foreign body forceps
6Fr/400mm (Type A)



W8300 Steel wire
0.8mm/300mm



B6000 Flexible brush
6Fr



A4303 Sealed cap



A4308 Infusion unit



HYSTEROSCOPE SET HS301 / HS302 / HS303



HS-301 SET

4302.30 Endoscope
30deg/4mm/302mm

Connect ATOMX light cable
Connect STORZ light cable
Connect WOLF light cable
Connect OLYMPUS light cable
Connect ACMI light cable

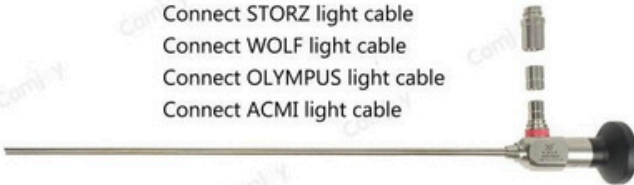

S1623 Inner sheath & obturator
16Fr/230mm

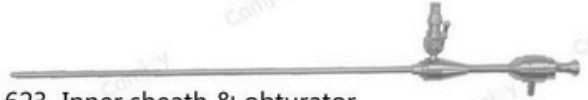

S1921 Outer sheath
19.5Fr/210mm



A4302 Out-flow valve



A4301 In-flow valve



HS-302 SET

3302.30 Endoscope
30deg/3mm/302mm

Connect ATOMX light cable
Connect STORZ light cable
Connect WOLF light cable
Connect OLYMPUS light cable
Connect ACMI light cable

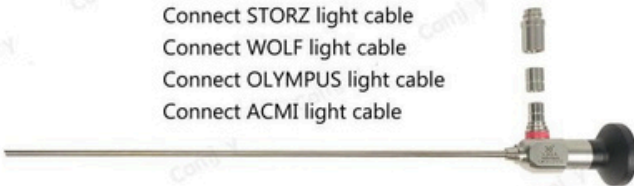

S1223 Inner sheath & obturator
12Fr/230mm

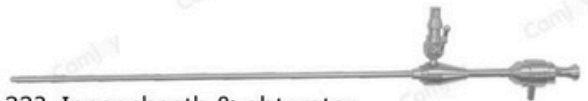

S1521 Outer sheath
15Fr/210mm



A4302 Out-flow valve



A4301 In-flow valve



HS-303 SET

3302.12 Endoscope
12deg/3mm/302mm

Connect ATOMX light cable
Connect STORZ light cable
Connect WOLF light cable
Connect OLYMPUS light cable
Connect ACMI light cable

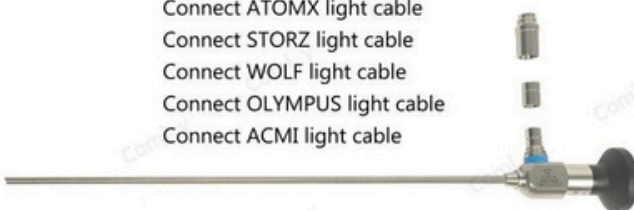

S1223A Inner sheath & obturator
12Fr/230mm



S1521 Outer sheath
15Fr/210mm



A4302 Out-flow valve



A4301 In-flow valve



HYSTEROSCOPE SET HS401

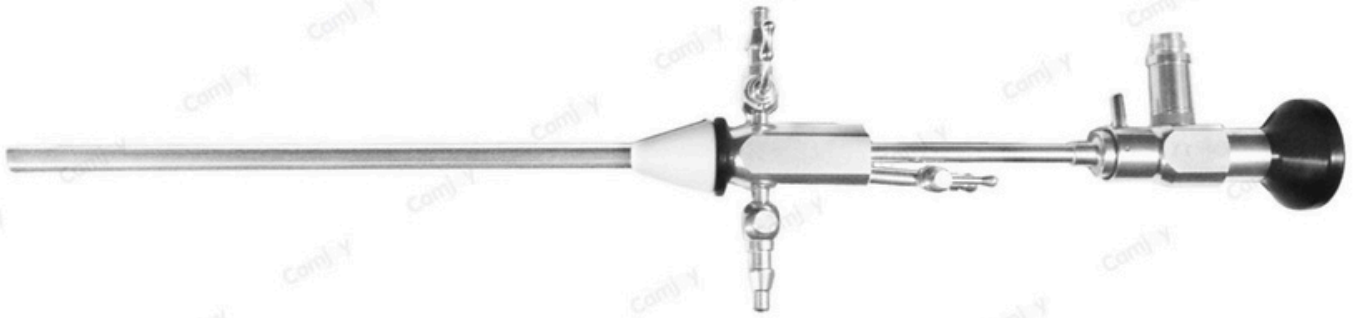

4302.30 Endoscope
30deg/4mm/302mm

Connect ATOMX light cable
Connect STORZ light cable
Connect WOLF light cable
Connect OLYMPUS light cable
Connect ACMI light cable

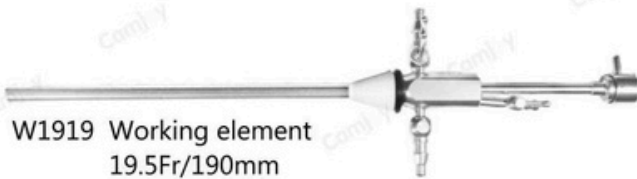
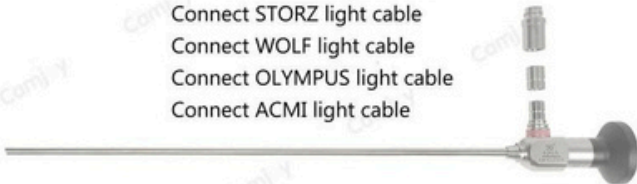

W1919 Working element
19.5Fr/190mm



S1901 Obturator
12Fr

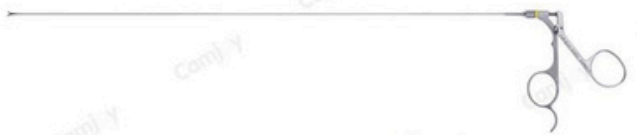

R6340S1 Rigid Scissors
6Fr/340mm

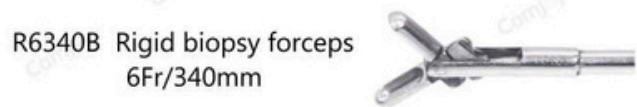

R6340B Rigid biopsy forceps
6Fr/340mm



R6340G Rigid grasping ring forceps
6Fr/340mm

R6340G3 Rigid grasping forceps
6Fr/340mm



R6340F Rigid foreign body forceps
6Fr/340mm



R6340T Rigid saw-tooth forceps
6Fr/340mm



A4301 In-flow valve



A4302 Out-flow valve



W8300 Steel wire
0.8mm/300mm



B6000 Flexible brush
6Fr



A4303 Sealed cap



HYSTEROSCOPE SET HS501



4302.30 Endoscope
30deg/4mm/302mm

Connect ATOMX light cable
Connect STORZ light cable
Connect WOLF light cable
Connect OLYMPUS light cable
Connect ACMI light cable

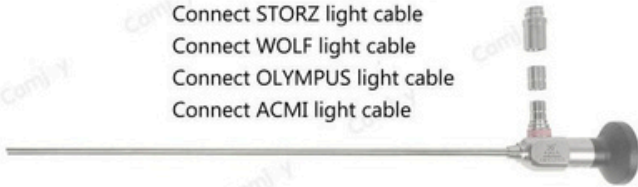

S2021 Outer sheath & obturator
20.5Fr/210mm

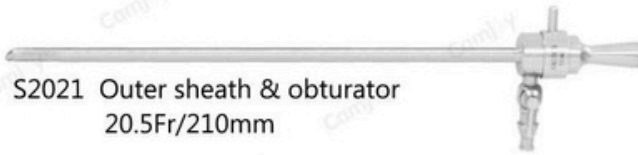

W1822 Working element
18.5Fr/220mm

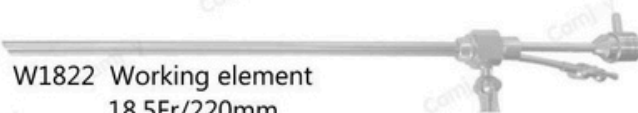

R6340S1 Rigid Scissors
6Fr/340mm



R6340B Rigid biopsy forceps
6Fr/340mm



R6340G Rigid grasping ring forceps
6Fr/340mm



R6340G3 Rigid grasping forceps
6Fr/340mm



R6340F Rigid foreign body forceps
6Fr/340mm



R6340T Rigid saw-tooth forceps
6Fr/340mm



A4301 In-flow valve



A4302 Out-flow valve



W8300 Steel wire
0.8mm/300mm



B6000 Flexible brush
6Fr



A4303 Sealed cap



HYSTEROSCOPE SET HS502A



3302.30 Endoscope
30deg/3mm/302mm

Connect ATOMX light cable
Connect STORZ light cable
Connect WOLF light cable
Connect OLYMPUS light cable
Connect ACMI light cable

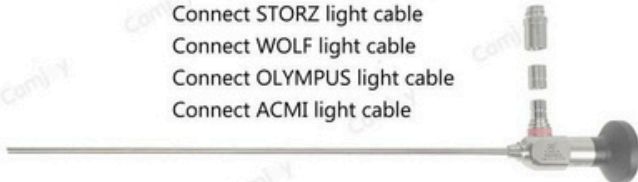

S1621 Outer sheath & obturator
16.5Fr/210mm

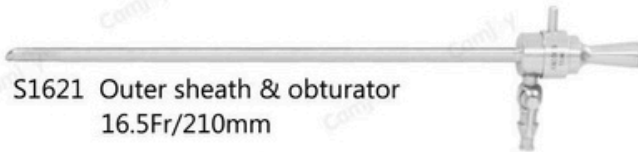

W1422 Working element
14.5Fr/220mm

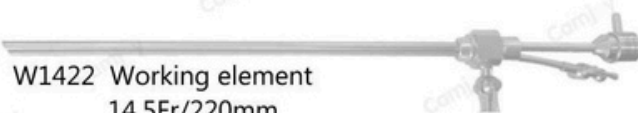

R5340S1 Rigid Scissors
5Fr/340mm



R5340B Rigid biopsy forceps
5Fr/340mm



R5340G Rigid grasping ring forceps
5Fr/340mm



R5340G3 Rigid grasping forceps
5Fr/340mm



R5340F Rigid foreign body forceps
5Fr/340mm



R5340T Rigid saw-tooth forceps
5Fr/340mm



A4301 In-flow valve



A4302 Out-flow valve



W8300 Steel wire
0.8mm/300mm



B6000 Flexible brush
6Fr



A4303 Sealed cap



HYSTEROSCOPE SET HS502B



9302.30 Endoscope
30deg/2.9mm/302mm

Connect ATOMX light cable
Connect STORZ light cable
Connect WOLF light cable
Connect OLYMPUS light cable
Connect ACMI light cable

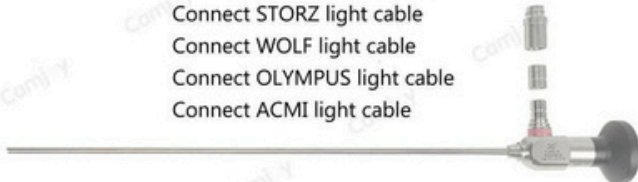

S1621 Outer sheath & obturator
16.5Fr/210mm

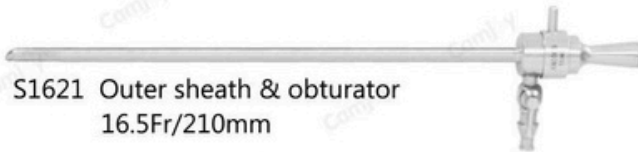

W1422 Working element
14.5Fr/220mm

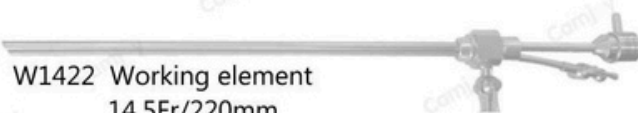

R5340S1 Rigid Scissors
5Fr/340mm



R5340B Rigid biopsy forceps
5Fr/340mm



R5340G Rigid grasping ring forceps
5Fr/340mm



R5340G3 Rigid grasping forceps
5Fr/340mm



R5340F Rigid foreign body forceps
5Fr/340mm



R5340T Rigid saw-tooth forceps
5Fr/340mm



A4301 In-flow valve



A4302 Out-flow valve



W8300 Steel wire
0.8mm/300mm



B6000 Flexible brush
6Fr



A4303 Sealed cap



HYSTEROSCOPE SET HS503



3302.30 Endoscope
30deg/3mm/302mm

Connect ATOMX light cable
Connect STORZ light cable
Connect WOLF light cable
Connect OLYMPUS light cable
Connect ACMI light cable

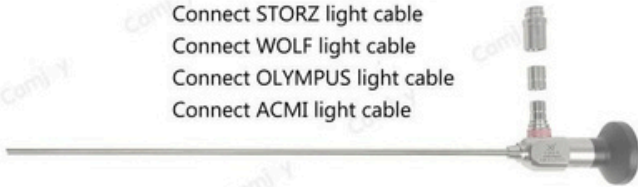

S1821 Outer sheath & obturator
18Fr/210mm

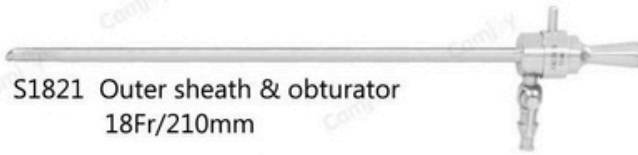

W1622 Working element
16Fr/220mm



R6340S1 Rigid Scissors
6Fr/340mm



R6340B Rigid biopsy forceps
6Fr/340mm



R6340G Rigid grasping ring forceps
6Fr/340mm



R6340G3 Rigid grasping forceps
6Fr/340mm



R6340F Rigid foreign body forceps
6Fr/340mm



R6340T Rigid saw-tooth forceps
6Fr/340mm



A4301 In-flow valve



A4302 Out-flow valve



W8300 Steel wire
0.8mm/300mm



B6000 Flexible brush
6Fr



A4303 Sealed cap



HYSTEROSCOPE SET HS601A



3302.30 Endoscope
30deg/3mm/302mm

Connect ATOMX light cable
Connect STORZ light cable
Connect WOLF light cable
Connect OLYMPUS light cable
Connect ACMI light cable

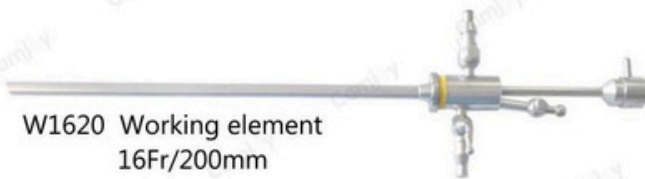
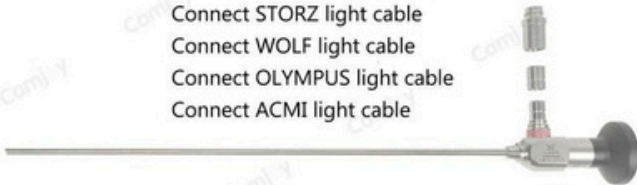

W1620 Working element
16Fr/200mm



R6340S1 Rigid Scissors
6Fr/340mm

R6340B Rigid biopsy forceps
6Fr/340mm



R6340G Rigid grasping ring forceps
6Fr/340mm



R6340G3 Rigid grasping forceps
6Fr/340mm



R6340F Rigid foreign body forceps
6Fr/340mm



R6340T Rigid saw-tooth forceps
6Fr/340mm



A4300 In-flow valve



A4302 Out-flow valve



W8300 Steel wire
0.8mm/300mm



B6000 Flexible brush
6Fr



A4303 Sealed cap



HYSTEROSCOPE SET HS601B



3302.30 Endoscope
30deg/3mm/302mm

Connect ATOMX light cable
Connect STORZ light cable
Connect WOLF light cable
Connect OLYMPUS light cable
Connect ACMI light cable

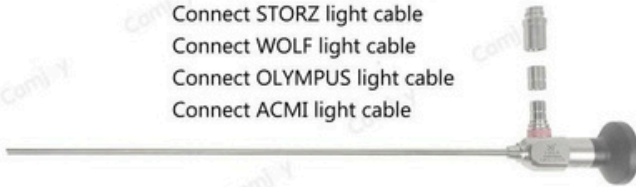

W1420 Working element
14Fr/200mm



R4340S1 Rigid Scissors
4Fr/340mm



R4340B Rigid biopsy forceps
4Fr/340mm



R4340G Rigid grasping ring forceps
4Fr/340mm



R4340G3 Rigid grasping forceps
4Fr/340mm



R4340F Rigid foreign body forceps
4Fr/340mm



R4340T Rigid saw-tooth forceps
4Fr/340mm



A4300 In-flow valve



A4302 Out-flow valve



W8300 Steel wire
0.8mm/300mm



B6000 Flexible brush
6Fr



A4303 Sealed cap



HYSTEROSCOPE SET HS701A / HS701B

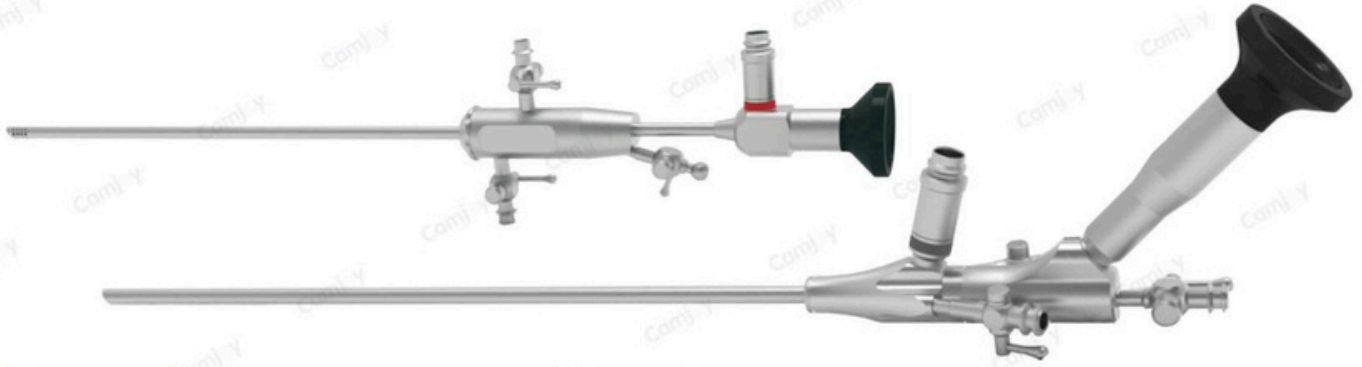

HS-701A SET

1620.30 Endoscope(straight type)
30deg/16Fr/205mm

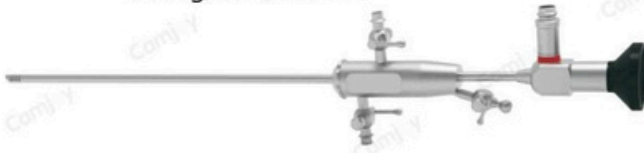

HS-701B SET

5217.30 Endoscope(oblique type)
30deg/5mm/217mm



R5340G3 Rigid grasping forceps
5Fr/340mm



R5340F Rigid foreign body forceps
5Fr/340mm



R5340T Rigid saw-tooth forceps
5Fr/340mm



A4301 In-flow valve



A4302 Out-flow valve



R5340S1 Rigid Scissors
5Fr/340mm

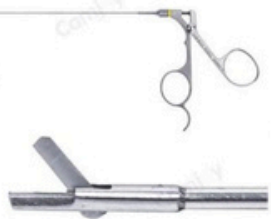

R5340B Rigid biopsy forceps
5Fr/340mm



R5340G Rigid grasping ring forceps
5Fr/340mm



W8300 Steel wire
0.8mm/300mm



B6000 Flexible brush
6Fr



A4303 Sealed cap



HYSTEROSCOPE SET HS701C



3217.00 Endoscope(oblique type)
0deg/3.9mm/217mm

3217.12 Endoscope(oblique type)
12deg/3.9mm/217mm



H7001 Endoscope Handle



R5340S1 Rigid Scissors
5Fr/340mm



R5340B Rigid biopsy forceps
5Fr/340mm



R5340G Rigid grasping ring forceps
5Fr/340mm



R5340G3 Rigid grasping forceps
5Fr/340mm



R5340F Rigid foreign body forceps
5Fr/340mm



R5340T Rigid saw-tooth forceps
5Fr/340mm



A4301 In-flow valve



A4302 Out-flow valve



W8300 Steel wire
0.8mm/300mm



B6000 Flexible brush
6Fr



A4303 Sealed cap



HYSTEROSCOPE SET HS801



2419.12 Endoscope(Z type)
12deg/24Fr/190mm/4.5mm
2419.00 Endoscope(Z type)
0deg/24Fr/190mm/4.5mm



S2617 Outer sheath & obturator
26Fr/177.5mm



H3360S1 Scissors(hook type)
3mm/360mm



H3360S2 Scissors(double-action curved)
3mm/360mm



H3360S3 Scissors(single-action)
3mm/360mm



H3360S4 Scissors(double-action)
3mm/360mm



H3360F1 Forceps(dissecting curved)
3mm/360mm



H3360F2 Forceps(punch grasping)
3mm/360mm



H3360B Forceps(biopsy)
3mm/360mm



H3360F3 Forceps(grasping)
3mm/360mm



H3360M1 Electric coagulator(monopolar)
3mm/360mm



H3360M2 Electric hook(monopolar)
3mm/360mm



H3360M3 Electric hook(monopolar)
3mm/360mm



H3360B1 Electric coagulator(bipolar)
3mm/360mm



H3360B2 Electric spade(bipolar)
3mm/360mm



H3360B3 Electric spade(bipolar)
3mm/360mm



HF300M Monopolar HF cord
3m





















HF300B Bipolar HF cord
3m



HYSTEROSCOPE SET HS901

"Animation class" high-definition light path design
 In line with human engineering, traction, image clarity
 Special double channel outlet hole design
 Water flow fast and sufficient



<p>2419.12T Endoscope(Y type) 12deg/24Fr/190mm/4.0mm</p>  <p>S2618T Outer sheath 26Fr/180mm</p>  <p>S2600T Obturator</p> 	<p>H3360F2 Forceps(punch grasping) 3mm/360mm</p>  <p>H3360B Forceps(biopsy) 3mm/360mm</p>  <p>H3360F3 Forceps(grasping) 3mm/360mm</p> 
<p>H3360S1 Scissors(hook type) 3mm/360mm</p>  <p>H3360S2 Scissors(double-action curved) 3mm/360mm</p>  <p>H3360S3 Scissors(single-action) 3mm/360mm</p>  <p>H3360S4 Scissors(double-action) 3mm/360mm</p>  <p>H3360F1 Forceps(dissecting curved) 3mm/360mm</p> 	<p>H3360M1 Electric coagulator(monopolar) 3mm/360mm</p>  <p>H3360M2 Electric hook(monopolar) 3mm/360mm</p>  <p>H3360M3 Electric hook(monopolar) 3mm/360mm</p>  <p>H3360B1 Electric coagulator(bipolar) 3mm/360mm</p>  <p>H3360B2 Electric spade(bipolar) 3mm/360mm</p>  <p>H3360B3 Electric spade(bipolar) 3mm/360mm</p>  <p>HF300M Monopolar HF cord 3m</p>  <p>HF300B Bipolar HF cord 3m</p> 

Multifunctional uterus-lifting work apparatus

A type work apparatus

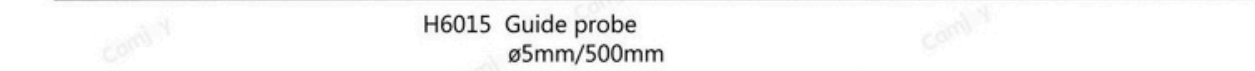

B type work apparatus

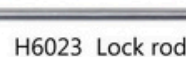
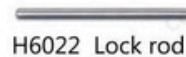

Multifunctional uterus-lifting work apparatus

C type work apparatus (pediatrics)



H6001C Uterus-lifting work apparatus



H6031 Apparatus cup
ø31mm/53mm



H6032 Apparatus cup
ø36mm/56mm



H6033 Apparatus cup
ø39mm/57mm



H6035 Guide probe
ø3mm/470mm



H6036 Manipulative pole
ø10mm/270mm



H6037 Lock rod
ø5mm/60mm



H6039 Manipulative head



H6031 Apparatus head



H6038 Handle
ø13.5mm/170mm



H6040 Manipulative head

D type multifunctional work apparatus



H6001D Uterus-lifting work apparatus
with 6pcs heads



H6043 Apparatus head
3#



H6044 Apparatus head
4#



H6045 Apparatus head
5#



H6046 Apparatus head
6#



H6041 Apparatus cup
1#



H6042 Apparatus cup
2#

Electric uterus-cutter and accessories

Electric uterus-cutter



H7001 Hand control motor

H7002 Connection cable

H7003 Control unit

Accessories



H7004 Grasping forceps
ø5mm/420mm



H7005 Grasping forceps
ø10mm/420mm

Electric uterus-cutter and accessories

Accessories

-  H7006 Hysteromyoma drill
ø5mm/420mm
-  H7007 Hysteromyoma drill
ø10mm/420mm
-  H7008 Uterus measuring stick
ø5mm/500mm
-  H7009 Moving bar
ø5mm/420mm
-  H7010 Knot-pushing stick
ø5mm/330mm
-  H7011 Uterine manipulator
400mm
-  H7012 Guide probe
ø10mm/330mm

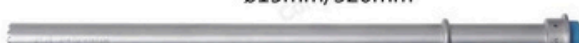
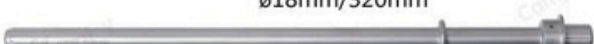
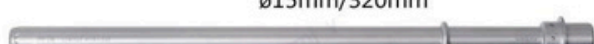
-  H7013 Cutting tube (TAH)
ø15mm/320mm
-  H7014 Cutting tube (TAH)
ø18mm/320mm
-  H7015 Cutting tube (LAVH)
ø15mm/320mm
-  H7016 Cutting tube (LAVH)
ø18mm/320mm



H7017 Trocar sleeve
ø15mm/105mm



H7018 Trocar sleeve
ø18mm/105mm



H7019 Reducer
ø18mm-5mm



H7020 Reducer
ø15mm-5mm



H7021 Dilator
ø10mm-15mm



H7022 Dilator
ø10mm-18mm



H7023 Cervical forceps (long)
60mm(50mm/70mm/90mm)



H7024 Cervical forceps
250mm

Vaginal instruments

Vaginectomy Instruments

H8001 Double grasping forceps



H8002 Single grasping forceps



H8003 Ligament hook-shape forceps



H8004 Vaginal pressor



H8007 Myoma stripping



H8005 Cervical pressor



Vaginal retractor

H8008 Vagina hook 35mm



H8011 Vagina hook 35mm (with fiber and suction)



H8009 Vagina hook 30mm



H8012 Vagina hook 40mm (with fiber and suction)



H8010 Vagina hook (with fiber) 35mm

H8013 Hemostatic forceps (straight)



H8014 Hemostatic forceps (curved)

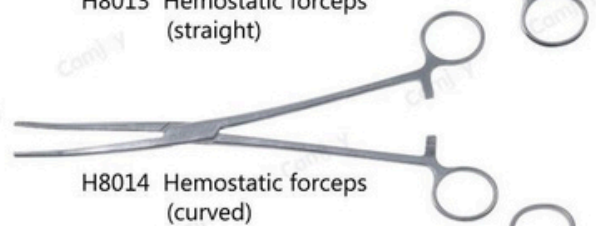

H8015 Ligament hook-shape forceps

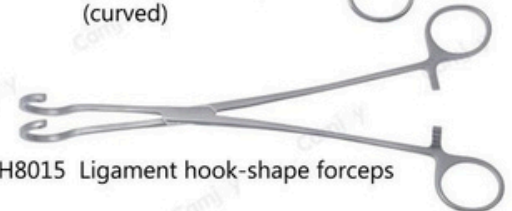

Vaginal suture retractor

H8016 Draw hook 42mm



H8017 Draw hook 32mm



H8018 Draw hook 22mm



H8019 Draw hook 16mm



H8020 Draw hook 12mm



H8021 Suture needle ø3mm, left



H8022 Suture needle ø3mm



H8023 Suture needle ø3mm, right



BIPOLAR RESECTOSCOPE SET

BRS109 (Click Locked)



4302.30 Endoscope(red)
30deg/4mm/302mm



Connect ATOMX light cable
Connect STORZ light cable
Connect WOLF light cable
Connect OLYMPUS light cable
Connect ACMI light cable



W9001A Working element
(Active)



W9001P Working element
(Passive)



C9011 Cutting electrode
(Bipolar, thick)



C9012 Cutting electrode
(Bipolar, thin)



C9013 Cutting electrode
(Bipolar, small)



C9014 Cutting electrode
(Bipolar, big)



S2618-9 Outer sheath
26Fr/180mm



S2419-9 Inner sheath with obturator
24Fr/196.5mm

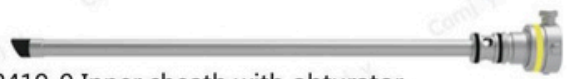

S2400-9 Inner sheath adaptor



R3340 Cleaning rod
φ3mm/340mm



A4301 In-flow valve



A4303 Sealed cap



A4305 Hoffman&connector



F1695 Fistula instrument 16Fr/95mm

F1895 Fistula instrument 18Fr/95mm

F2095 Fistula instrument 20Fr/95mm

F2295 Fistula instrument 22Fr/95mm

F2495 Fistula instrument 24Fr/95mm



BIPOLAR RESECTOSCOPE SET

BRS108A (click locked, adult type)



4302.30 Endoscope(red)
30deg/4mm/302mm

- Connect ATOMX light cable
- Connect STORZ light cable
- Connect WOLF light cable
- Connect OLYMPUS light cable
- Connect ACMI light cable

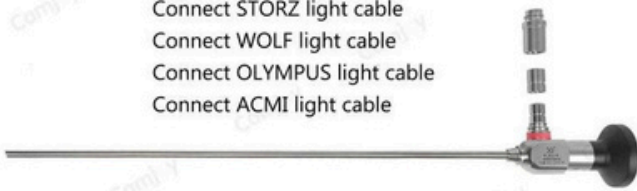
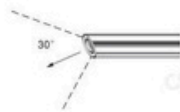

W8001P Working element
(Passive)

W8001A Working element
(Active)

C8011 Loop electrode
(Bipolar, 90deg)

C8012 Loop electrode
(Bipolar, straight)

C8013 Needle electrode
(Bipolar)

C8014 Knife electrode
(Bipolar)

C8015 Roller electrode
(Bipolar)

C8016 Rollerball electrode
(Bipolar)

C8017 Strip electrode
(Bipolar)



S2618-8A Outer sheath
26Fr/180mm



S2420-8A Inner sheath with obturator
24Fr/200mm

S2400-8A Inner sheath adaptor

R3340 Cleaning rod
φ3mm/340mm

H8000 HF cord
(Bipolar, 3m)

A4301 In-flow valve

A4303 Sealed cap

A4305 Hoffman&connector



F1695 Fistula instrument	16Fr/95mm
F1895 Fistula instrument	18Fr/95mm
F2095 Fistula instrument	20Fr/95mm
F2295 Fistula instrument	22Fr/95mm
F2495 Fistula instrument	24Fr/95mm



BIPOLAR RESECTOSCOPE SET

BRS108C1 (click locked, child type)



3302.30 Endoscope(red)
30deg/3mm/302mm

- Connect ATOMX light cable
- Connect STORZ light cable
- Connect WOLF light cable
- Connect OLYMPUS light cable
- Connect ACMI light cable

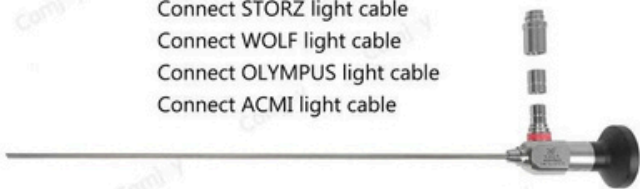
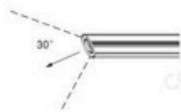

W8002P Working element
(Passive)

W8002A Working element
(Active)

C8021 Loop electrode
(Bipolar, 90deg)

C8022 Loop electrode
(Bipolar, straight)

C8023 Needle electrode
(Bipolar)

C8024 Knife electrode
(Bipolar)

C8025 Roller electrode
(Bipolar)

C8026 Rollerball electrode
(Bipolar)

C8027 Strip electrode
(Bipolar)



S2318-8C Outer sheath
23Fr/180mm



S2120-8C Inner sheath with obturator
21Fr/200mm



S2100-8C Inner sheath adaptor



R3340 Cleaning rod
φ3mm/340mm



H8000 HF cord
(Bipolar, 3m)



A4301 In-flow valve



A4303 Sealed cap



A4305 Hoffman&connector



F1695 Fistula instrument 16Fr/95mm

F1895 Fistula instrument 18Fr/95mm

F2095 Fistula instrument 20Fr/95mm

F2295 Fistula instrument 22Fr/95mm

F2495 Fistula instrument 24Fr/95mm

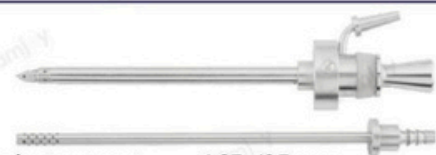

BIPOLAR RESECTOSCOPE SET

BRS108C2 (click locked, child type)



9302.30 Endoscope(red)
30deg/2.9mm/302mm

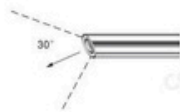

- Connect ATOMX light cable
- Connect STORZ light cable
- Connect WOLF light cable
- Connect OLYMPUS light cable
- Connect ACMI light cable

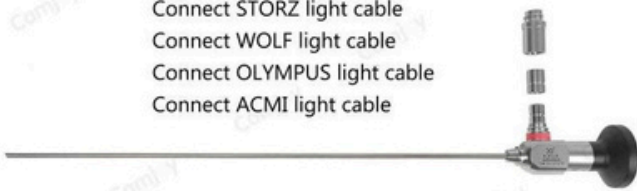

W8002P Working element
(Passive)

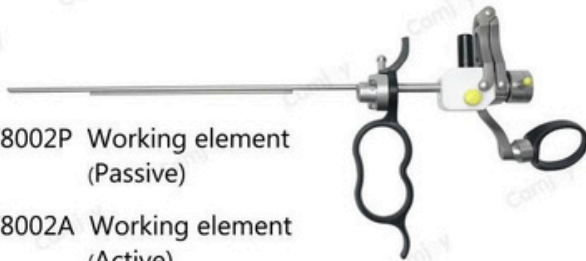

W8002A Working element
(Active)

C8021 Loop electrode
(Bipolar, 90deg)



C8022 Loop electrode
(Bipolar, straight)



C8023 Needle electrode
(Bipolar)



C8024 Knife electrode
(Bipolar)



C8025 Roller electrode
(Bipolar)



C8026 Rollerball electrode
(Bipolar)



C8027 Strip electrode
(Bipolar)



S2318-8C Outer sheath
23Fr/180mm



S2120-8C Inner sheath with obturator
21Fr/200mm



S2100-8C Inner sheath adaptor



R3340 Cleaning rod
φ3mm/340mm



H8000 HF cord
(Bipolar, 3m)



A4301 In-flow valve



A4303 Sealed cap



A4305 Hoffman&connector



F1695 Fistula instrument 16Fr/95mm

F1895 Fistula instrument 18Fr/95mm

F2095 Fistula instrument 20Fr/95mm

F2295 Fistula instrument 22Fr/95mm

F2495 Fistula instrument 24Fr/95mm

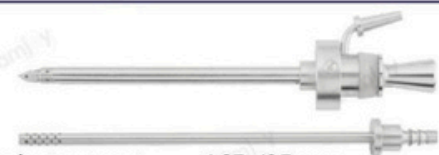

BIPOLAR RESECTOSCOPE SET

BRS107 (Click Locked)



4282.30 Endoscope(red)
30deg/4mm/282mm

Connect ATOMX light cable
Connect STORZ light cable
Connect WOLF light cable
Connect OLYMPUS light cable
Connect ACMI light cable

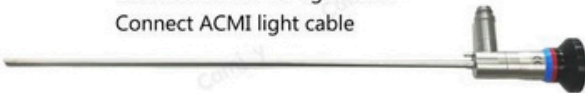

W7001A Working element
(Active)



W7001P Working element
(Passive)



C7011 Needle electrode
(Bipolar, plasma)



C7012 Coag electrode
(Bipolar, plasma)



C7013 Knife electrode
(Bipolar, plasma)



C7014 Strip electrode
(Bipolar, plasma)



C7015 Loop electrode
(Bipolar, plasma)



S2600-7 Outer sheath
26.5Fr

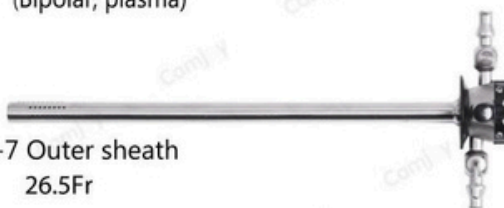

S2400-7 Inner sheath
24.5Fr



S2401-7 Adjustable obturator



S2402-7 Inner sheath adaptor



R3340 Cleaning rod
φ3mm/340mm



H7000 HF cord
(Bipolar, 3m)



A4301 In-flow valve



A4303 Sealed cap



A4306 Hoffman&connector
(Compatible with Olympus)



F1695 Fistula instrument 16Fr/95mm

F1895 Fistula instrument 18Fr/95mm

F2095 Fistula instrument 20Fr/95mm

F2295 Fistula instrument 22Fr/95mm

F2495 Fistula instrument 24Fr/95mm

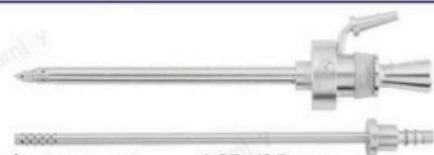

BIPOLAR RESECTOSCOPE SET

BRS106 (Click Locked)



4302.30 Endoscope(red)
30deg/4mm/302mm

- Connect ATOMX light cable
- Connect STORZ light cable
- Connect WOLF light cable
- Connect OLYMPUS light cable
- Connect ACMI light cable

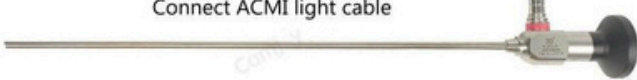
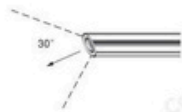

W6001A Working element
(Active)



W6001P Working element
(Passive)



C6011 Loop electrode
(Bipolar, plasma)

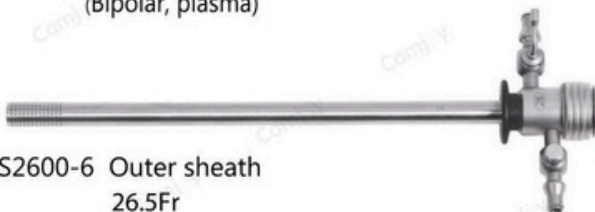

S2600-6 Outer sheath
26.5Fr

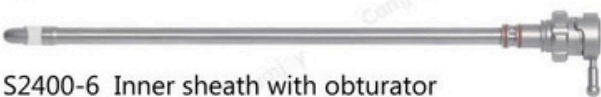

S2400-6 Inner sheath with obturator
24.5Fr

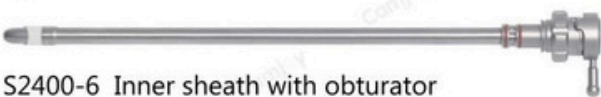

S2403-6 Inner sheath adaptor



R3340 Cleaning rod
φ3mm/340mm



H6000 HF cord
(Bipolar, 3m)



A4301 In-flow valve



A4303 Sealed cap



A4305 Hoffman&connector
(Compatible with Storz)



- | | |
|--------------------------|-----------|
| F1695 Fistula instrument | 16Fr/95mm |
| F1895 Fistula instrument | 18Fr/95mm |
| F2095 Fistula instrument | 20Fr/95mm |
| F2295 Fistula instrument | 22Fr/95mm |
| F2495 Fistula instrument | 24Fr/95mm |

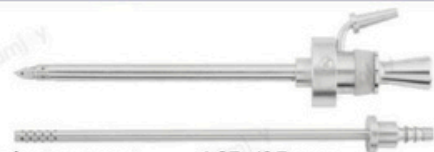

LASER RESECTOSCOPE SET

LRS105 (click locked, adult type)



4302.30 Endoscope(red)
30deg/4mm/302mm

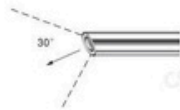

- Connect ATOMX light cable
- Connect STORZ light cable
- Connect WOLF light cable
- Connect OLYMPUS light cable
- Connect ACMI light cable

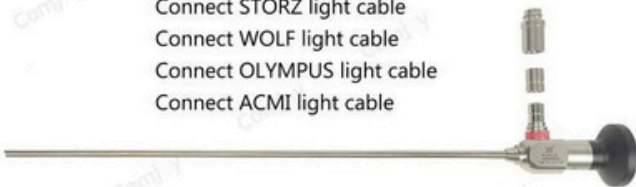

W5001P Working element
(Passive)



W5001A Working element
(Active)



- F5010 Fiber Adapter (φ1.0mm)
- F5012 Fiber Adapter (φ1.2mm)
- F5014 Fiber Adapter (φ1.4mm)
- F5016 Fiber Adapter (φ1.6mm)
- F5018 Fiber Adapter (φ1.8mm)



S2618-5 Outer sheath
26Fr/180mm

S2420-5 Inner sheath with obturator
24Fr/200mm

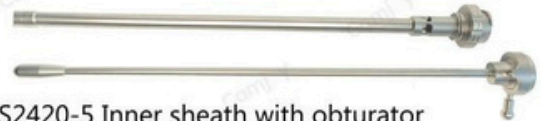

S2400-5 Inner sheath adaptor



R3340 Cleaning rod
φ3mm/340mm



A4301 In-flow valve



A4303 Sealed cap



A4305 Hoffman&connector



- F1695 Fistula instrument 16Fr/95mm
- F1895 Fistula instrument 18Fr/95mm
- F2095 Fistula instrument 20Fr/95mm
- F2295 Fistula instrument 22Fr/95mm
- F2495 Fistula instrument 24Fr/95mm



MONOPOLAR RESECTOSCOPE SET

MRS104 (Rotating Locked)



4302.30 Endoscope(red)
30deg/4mm/302mm

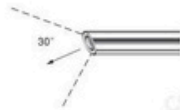

Connect ATOMX light cable
Connect STORZ light cable
Connect WOLF light cable
Connect OLYMPUS light cable
Connect ACMI light cable



W4001A Working element
(Active)

W4001P Working element
(Passive)



C4011 Cutting loops
(φ4mm/281mm)

C4012 Roll cutting loops
(φ4mm/287mm)

C4013 Spade-style cutting loops
(φ4mm/282mm)

C4014 Needle-type cutting loops
(φ4mm/288mm)

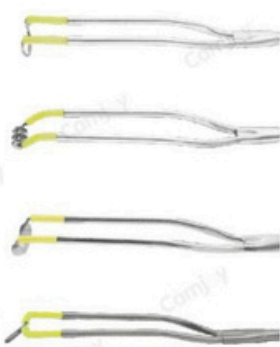

S2618-4 Outer sheath
26Fr/180mm



S2601-4 Obturator for outer sheath(Active)

S2419-4 Inner sheath & obturator(Oblique lip)
24Fr/195mm

R3340 Cleaning rod
φ3mm/340mm

H4000 HF cord
(Monopolar, 3m)

A4301 In-flow valve

A4303 Sealed cap

A4305 Hoffman&connector
(Compatible with Storz)



F1695 Fistula instrument	16Fr/95mm
F1895 Fistula instrument	18Fr/95mm
F2095 Fistula instrument	20Fr/95mm
F2295 Fistula instrument	22Fr/95mm
F2495 Fistula instrument	24Fr/95mm

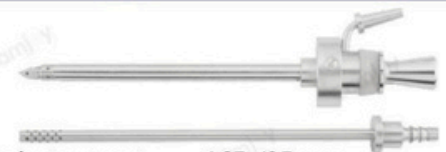

MONOPOLAR RESECTOSCOPE SET

MRS103 (Rotating Locked)



4302.12 Endoscope(blue)
12deg/4mm/302mm

Connect ATOMX light cable
Connect STORZ light cable
Connect WOLF light cable
Connect OLYMPUS light cable
Connect ACMI light cable

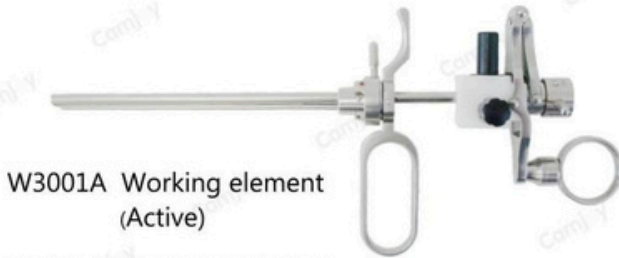

W3001A Working element
(Active)

W3001P Working element
(Passive)



C3011 Cutting loops
(φ4mm/282mm)



C3012 Roll cutting loops
(φ4mm/287mm)



C3013 Spade-style cutting loops
(φ4mm/282mm)



C3014 Needle-type cutting loops
(φ4mm/287mm)



C3015 Cutting tumour loops
(φ4mm/282mm)



S2718-3 Outer sheath
27Fr/180mm



S2701-3 Obturator for outer sheath(Active)



S2519-3 Inner sheath & obturator(Oblique lip)
25Fr/195mm



R3340 Cleaning rod
φ3mm/340mm

H4000 HF cord
(Monopolar, 3m)



A4301 In-flow valve



A4303 Sealed cap



A4305 Hoffman&connector
(Compatible with Storz)

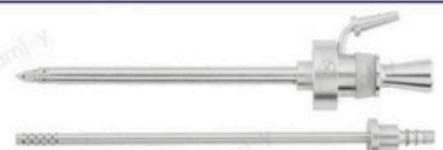

F1695 Fistula instrument 16Fr/95mm
F1895 Fistula instrument 18Fr/95mm
F2095 Fistula instrument 20Fr/95mm
F2295 Fistula instrument 22Fr/95mm
F2495 Fistula instrument 24Fr/95mm

